

YUEQING HONGYI ELECTRONICS CO., LTD  
乐清市宏一电子有限公司

SPECIFICATION FOR APPROVAL  
承认书

CUSTOMER 客户名称	
DESCRIPRION 产品名称	20 数显压力表系列连接器
ITEM NO 编 号	HY-D0006 (D06)
DATE 日 期	2024-08-22

CUSTOMER ACKNOWLEDGEMENT SEAL

客户承认印签

(APPROVAL) 核准	(ENGINEERING) 工程	(PURCHASE) 采购	(QUALITY) 品质
承认结果: <input type="checkbox"/> 通过 <input type="checkbox"/> 不通过 <input type="checkbox"/> 重新送样			

IS09001

IS014001

IS045001

IATF16949 体系认证

ADD: No. 30, Wenjing Road, Houyu village, Shifan street, Yueqing City, Zhejiang Province

地此: 浙江省乐清市石帆街道后屿文景路 30 号

TEL:0577-62380521

FAX: 0577-62381979 P.C:325608

http: //www.zhehongyi.com

E-MAIL:yaohongxiao88@126.com



# 产 品 承 认 书 目 录

1、封面	1-1
2、修订履历	2-2
3、目录	3-3
4、产品图纸	4-8

REV.	日期	ECN NO.	变更内容	制图
			DESCRIPTION	DRAWN

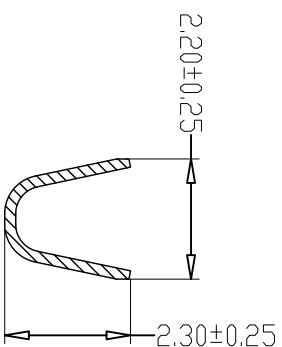
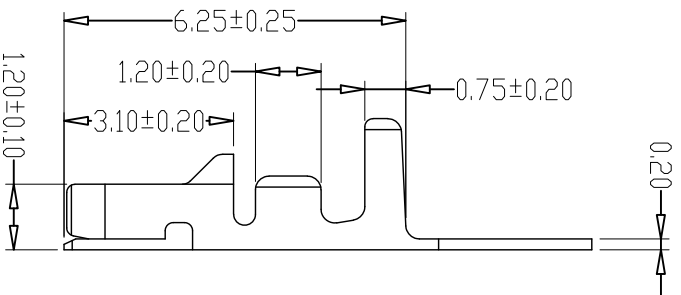
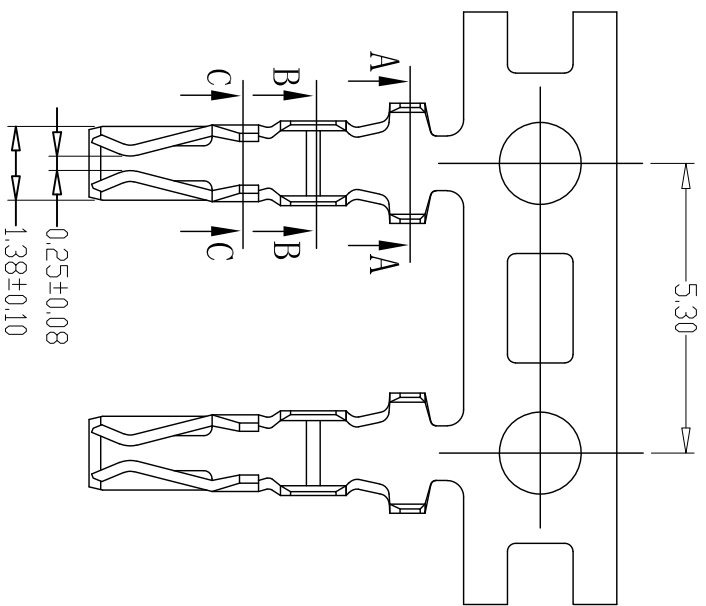

SEC:A-A

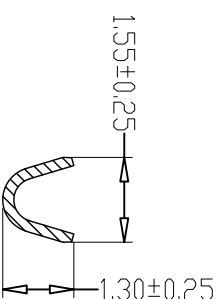

SEC:B-B

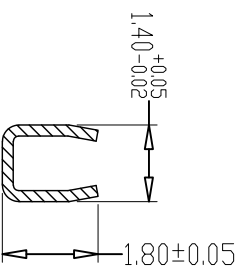

SEC:C-C

- SPECIFICATIONS
- 1、Current Rating: 2A AC, DC
  - 2、Voltage Rating: 50V AC, DC
  - 3、Temperature Range: -25°C~+85°C
  - 4、Contact Resistance: 20mΩ Max
  - 5、Insulation Resistance: 1000MΩ Min
  - 6、Withstanding Voltage: 800V AC/minute
  - 7、Material: Phosphoric bronze Tin-plated
  - 8、Applicable Wire Sizes: AWG#22~28#

GENERAL TOLERANCE		制图	料号	版本
X.±0.25	X.±2°	Mapping	2024, 08, 21	REV.
.X±0.20	.X±1°	审核	钱岳生	页次
.XX±0.15	.XX±0.5°	核准	张名	SHEET
.XXX±0.10	.XXX±0.5°	Approved	2024, 08, 22	1/1
		单位	MM	
		Units	SCALE	
			1:1	

乐清市宏一电子有限公司  
YueQing HongYi Electronics Co., Ltd

REV.	日期	ECN NO.	变更内容	制图
	DATE		DESCRIPTION	DRAWN

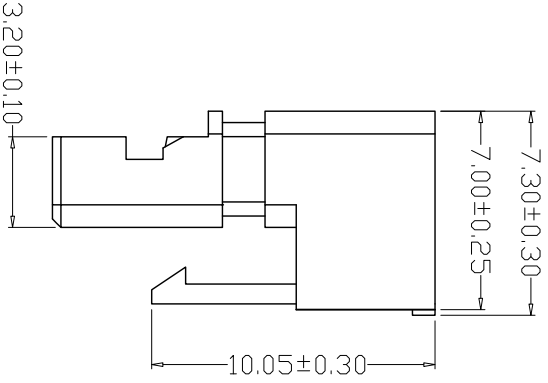
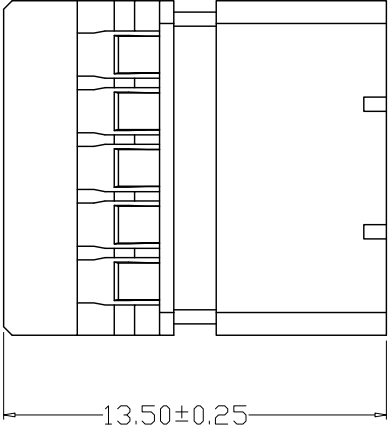
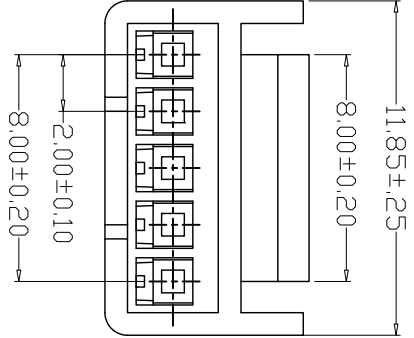
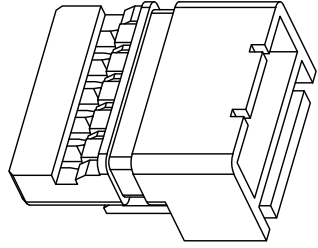

**SPECIFICATIONS**

- 1、Current Rating: 2A AC, DC
- 2、Voltage Rating: 50V AC, DC
- 3、Temperature Range: -25°C~+85°C
- 4、Contact Resistance: 20mΩ Max
- 5、Insulation Resistance: 1000 MΩ Min
- 6、Withstanding Voltage: 800V AC/minute
- 7、Material: PA66, UL94V-0 Black

GENERAL TOLERANCE		制图	姚勇	料号	D00006-5Y	版本	A
X $\pm$ 0.25	X $\pm$ 2°	Mapping	2024、08、21	PART NO.		REV.	
X $\pm$ 0.25	X $\pm$ 1°	审核	钱岳生	品名	20数显压力表-5Y	页次	1/1
.XX $\pm$ 0.15	.XX $\pm$ 0.5°	核准	张名	客户料号		SHBET	
.XXX $\pm$ 0.10	.XXX $\pm$ 0.5°	Approved	2024、08、22	CITM. NO.			
		单位	mm	比例			
		Units	SCALE				

乐清市宏一电子有限公司  
YueQing HongYi Electronics Co., Ltd

版本 REV.	日期 DATE	ECN NO.	变更内容 DESCRIPTION	制图 DRAWN

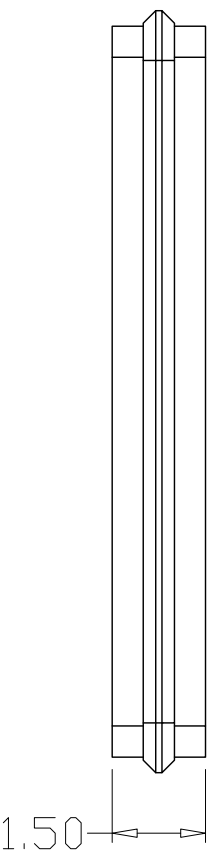
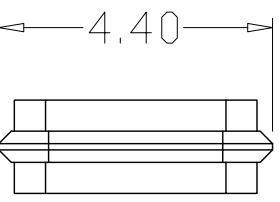
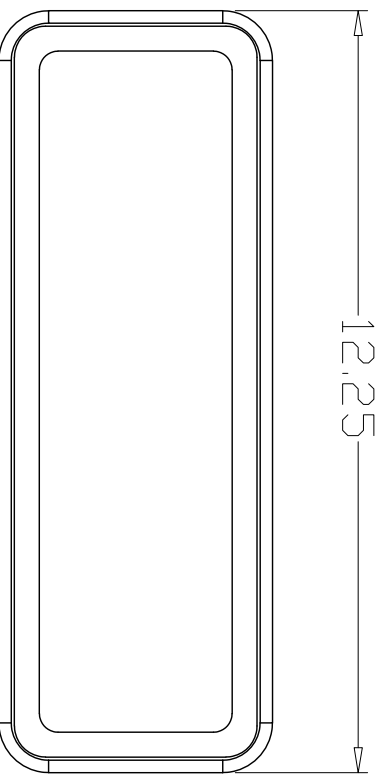
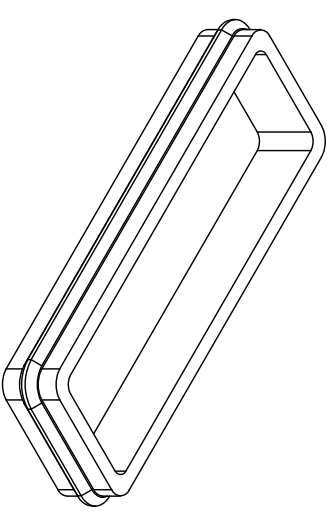

- SPECIFICATIONS**
- 1、Current Rating: 2A AC, DC
  - 2、Voltage Rating: 50V AC, DC
  - 3、Temperature Range: -25°C~+85°C
  - 4、Contact Resistance: 20mΩ Max
  - 5、Insulation Resistance: 1000mΩ Min
  - 6、Withstanding Voltage: 800V AC/minute
  - 7、Material: silica gel Blue

GENERAL TOLERANCE		制图 Mapping	料号 PART NO.	版本 REV.
X.±0.25	X.±2°	姚勇 2024、08、21	D00006-5Y (防水圈)	A
.X±0.20	.X±1°	审核 钱岳生 2024、08、21	品名 防水圈	页次 1/1
.XX±0.15	.XX±0.5°	核准 Approved	客户料号 CUST. NO.	
.XXX±0.10	.XXX±0.5°	单位 Units	张名 2024、08、22	
		MM SCALE	比例 SCALE	1:1

乐清市宏一电子有限公司  
YueQing HongYi Electronics Co., Ltd

配件参考图面，以实物为准

REV.	DATE	ECN NO.	变更内容 DESCRIPTION	制图 DRAWN

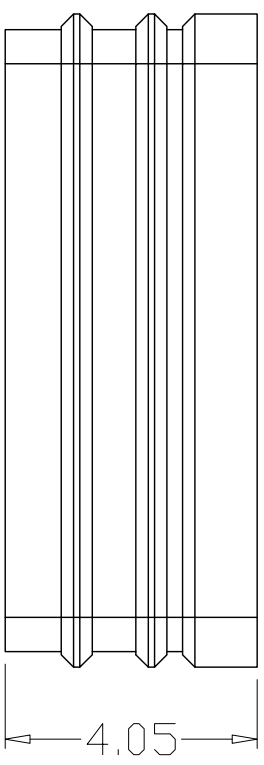
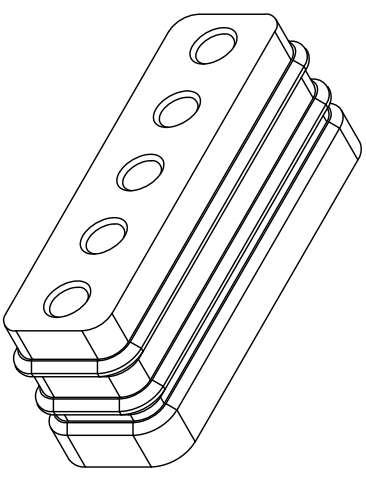
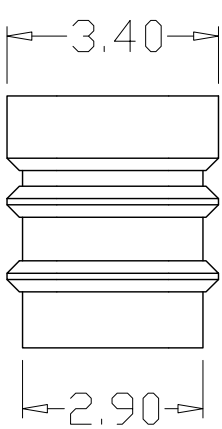
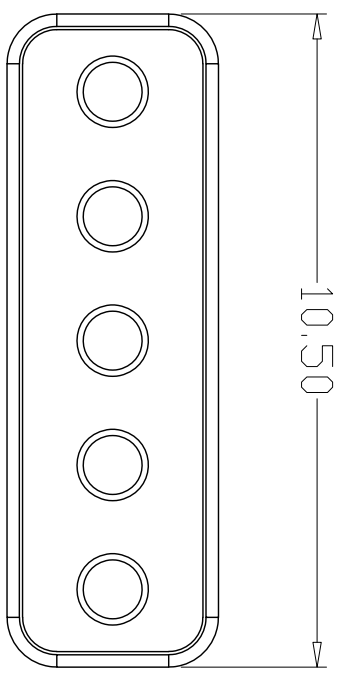

- SPECIFICATIONS**
- 1、Current Rating: 2A AC, DC
  - 2、Voltage Rating: 50V AC, DC
  - 3、Temperature Range: -25°C~+85°C
  - 4、Contact Resistance: 20mΩ Max
  - 5、Insulation Resistance: 1000mΩ Min
  - 6、Withstanding Voltage: 800V AC/minute
  - 7、Material: silica gel Blue

GENERAL TOLERANCE		制图 Mapping	料号 PART NO.	版本 REV.
X.±0.25	X.±2°	姚勇	D00006-5Y (防水塞)	A
.X±0.20	.X±1°	审核 钱岳生	品名 防水塞	页次 1/1
.XX±0.15	.XX±0.5°	核准 张名	客户料号 CUST. NO.	
.XXX±0.10	.XXX±0.5°	单位 Units	比例 SCALE	
		2024. 08. 21	2024. 08. 22	1:1

乐清市宏一电子有限公司  
YueDing HongYi Electronics Co., Ltd

配件参考图面，以实物为准

REV.	DATE	ECN NO.	变更内容 DESCRIPTION	制图 DRAWN

SPECIFICATIONS

- 1、 Current Rating: 2A AC, DC
- 2、 Voltage Rating: 50V AC, DC
- 3、 Temperature Range: -25°C~+85°C
- 4、 Contact Resistance: 20mΩ Max
- 5、 Insulation Resistance: 1000mΩ Min
- 6、 Withstanding Voltage: 800V AC/minute
- 7、 Material: silica gel

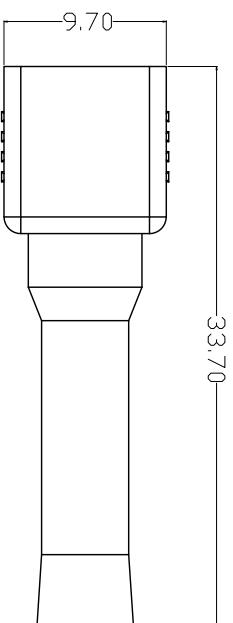
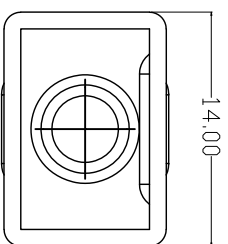
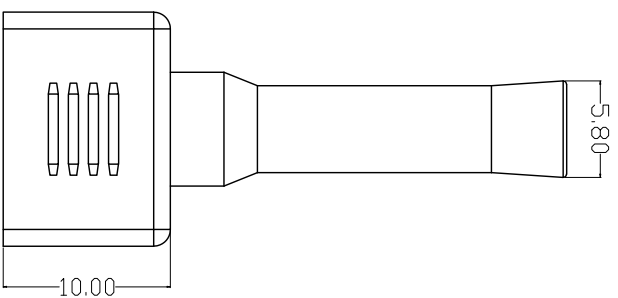
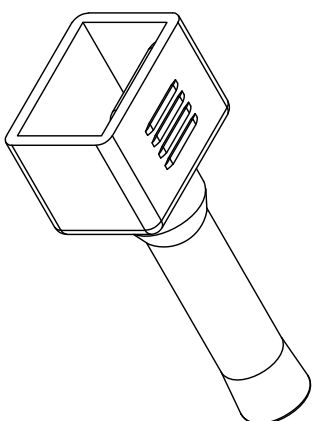

GENERAL TOLERANCE		制图 Mapping		料号 PART NO.		版本 REV.	
X.±0.25	X.±2°	张迎春	2022. 09、 10	D00006-5Y (防水套)	A		
.X±0.20	.X±1°	钱岳生	2022. 09、 10	防水套	1/1		
.XX±0.15	.XX±0.5°	核准	张名	客户料号			
.XXX±0.10	.XXX±0.5°	Approved	2022. 09、 11	CITM. NO.			
		单位 Units	MM	比例 SCALE	1:1		

配件参考图面，以实物为准

乐清市宏一电子有限公司  
YueQing HongYi Electronics Co., Ltd